

Panasonic

Digital Cordless Phone Operating Instructions

Model No. **KX-TCD430E**

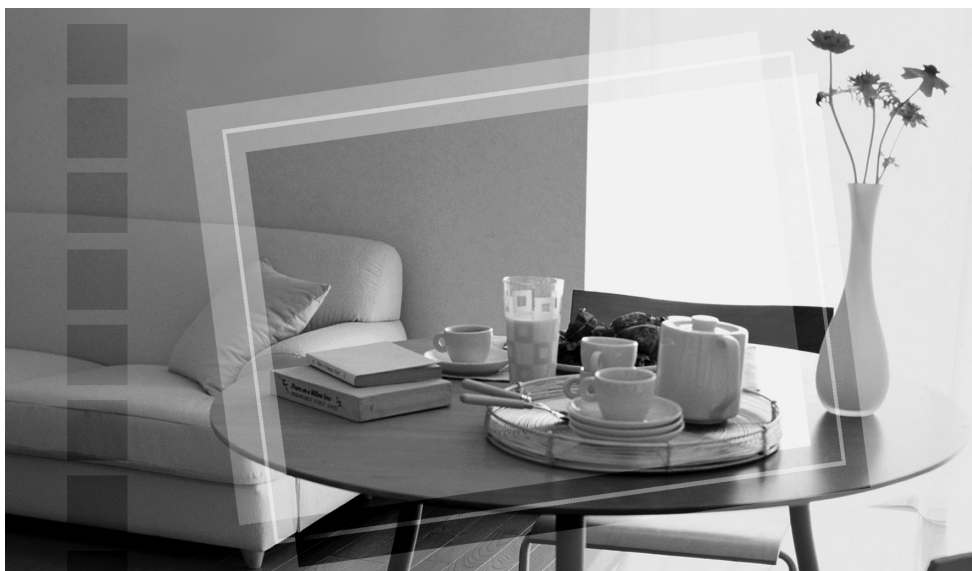
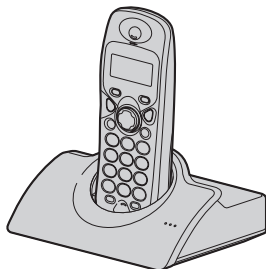

This unit is Caller ID compatible. To display the caller's phone number, you must subscribe to Caller ID service.

Charge the batteries for about 7 hours before initial use.

Please read these Operating Instructions before using the unit and save them for future reference.

Preparation

Accessory information	3
Important information	4
Location of controls	5
Connections	6
Battery installation	6
Battery charge	7
Battery replacement	8
Turning the power on/off	8
Setting the time and date	8

Telephone

Making calls	9
Answering calls	10
Phonebook	11
Hot key (quick dial)	12
Caller ID service	13

Useful Telephone Settings

Guide to handset settings	15
Handset settings	16
Guide to base unit settings	20
Base unit settings	20

Multi-unit Operation

Operating additional units	23
Registering a handset to a base unit	23
Setting all or selected handsets to ring	25
Intercom between handsets	26
Transferring calls between handsets/ Conference call	26

Useful Information

Troubleshooting	27
Technical information	29
Wall mounting	29
Conditions of guarantee	30

Index

Index	31
-----------------	----

Accessory information

Thank you for purchasing a new Panasonic digital cordless phone.

Sales and Support Information

Customer Care Centre

- For UK customers: 08700 100 076
- For Republic of Ireland customers: 01289 8333
- Visit our website for product information: www.panasonic.co.uk
- E-mail: customer.care@panasonic.co.uk

Direct Sales at Panasonic UK

- Order accessory and consumable items for your product with ease and confidence by phoning our Customer Care Centre Monday - Friday, 9:00 am - 5:30 pm. (Excluding public holidays)
- Or go on line through our Internet Accessory ordering application at www.panasonic.co.uk
- Most major credit and debit cards accepted.
- All enquiries transactions and distribution facilities are provided directly by Panasonic UK Ltd.
- It couldn't be simpler!
- Also available through our Internet is direct shopping for a wide range of finished products, take a browse on our website for further details.

Additional/replacement accessories

Model No.	Description
P03P	2 rechargeable nickel metal hydride (Ni-MH) batteries
P03H	2 rechargeable nickel cadmium (Ni-Cd) batteries
KX-A143E	Additional handset

Included accessories

AC adaptor
Order No. PQLV19EZ
(PQLV19E)

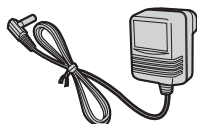

Telephone line cord
Order No. PQJA87S
(for UK)



Rechargeable batteries
(AAA size), Order No. HHR-4EPT/BA2 (P03P)



Battery cover
Order No. PQKK10134Z3

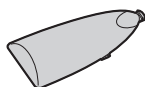

Operating instructions



Important information

General

- Use only the power supply included with this product, noted on page 3.
- Do not connect the AC adaptor to any AC outlet other than a standard 220–240 V AC outlet.
- This product is unable to make calls when:
 - The portable handset batteries need recharging or have failed.
 - There is a power failure.
 - The key lock feature is turned on.
 - The call bar feature is turned on (only numbers stored as emergency numbers can be called).
- Do not open the base unit or handset (other than to change the batteries).
- This product should not be used near emergency/intensive care medical equipment and should not be used by people with pacemakers.
- Care should be taken that objects do not fall onto, and liquids are not spilled into, the unit. Do not subject this product to excessive smoke, dust, mechanical vibration or shock.

Environment

- Do not use this product near water.
- This product should be kept away from heat sources such as radiators, cookers, etc. It should also not be placed in rooms where the temperature is less than 5 °C or greater than 40 °C.
- The AC adaptor is used as the main disconnect device. Ensure that the AC outlet is located/installed near the unit and is easily accessible.

Warning:

- To prevent the risk of electrical shock, do not expose this product to rain or any other type of moisture.

Location

For maximum distance and noise-free operation, place your base unit:

- Away from electrical appliances such as TVs, radios, personal computers or other phones.
- In a convenient, high and central location.

Battery caution

- We recommend using the batteries, noted on page 3. Use only rechargeable batteries.
- Do not mix old and new batteries.
- Do not dispose of batteries in a fire, as they may explode. Check local waste management codes for special disposal instructions.
- Do not open or mutilate the batteries. Released electrolyte from the batteries is corrosive and may cause burns or injury to the eyes or skin. The electrolyte may be toxic if swallowed.
- Exercise care when handling the batteries. Do not allow conductive materials such as rings, bracelets or keys to touch the batteries, otherwise a short circuit may cause the batteries and/or the conductive material to overheat and cause burns.
- Charge the batteries in accordance with the information provided in these operating instructions.

Safety caution

The ringer tone is reproduced through the handset receiver. To avoid damage to hearing, we recommend you answer incoming calls before holding the phone to your ear.

Location of controls

Handset

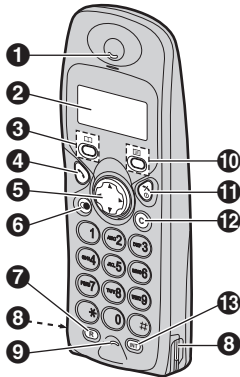

- 1 Receiver**
- 2 Display**
- 3 [☐] (Phonebook)**
- 4 [☎] (Talk)**
- 5 Navigator**
 - [▲][▼]: To search for the desired item in the setting menu, caller information or phonebook.
 - [▶]: To select the desired item or move the cursor to the right.
 - [◀]: To go back to the previous display or move the cursor to the left.
- 6 [●] (Redial/Pause)**
- 7 [R] (Recall)**
- 8 Charge contacts**
- 9 Microphone**
- 10 [☰] (Menu/OK)**
- 11 [⏻] (Off/Power)**
- 12 [C] (Clear)**
- 13 [INT] (Intercom)**

Display descriptions

Icons	Meaning
	Within range of base unit
	Out of range, no registration or no power on base unit
	Paging, intercom mode or accessing base unit
	Making or answering a call
	Phonebook mode
	Setting mode
	Battery strength is low
	Battery strength is high
	Call bar is on (page 18)
	Direct call is on (page 18)
	Key lock is on (page 9)
	Ringer volume is off (page 16)
	Displayed when you press [☎]

Base unit

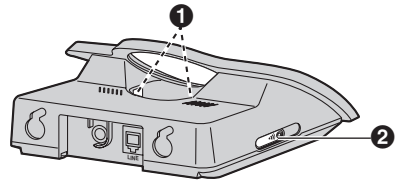

- 1 Charge contacts**
- 2 [☎] (Page)**

Connections

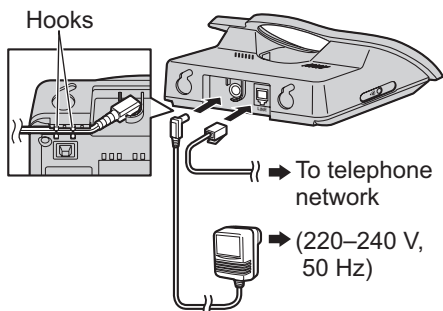

Note:

- If the AC outlet is connected to a switch, make sure the switch is on.
- If the handset is not charged, you cannot make or answer calls.
- Never install telephone wiring during a lightning storm.
- The AC adaptor must remain connected at all times. (It is normal for the adaptor to feel warm during use.)
- Use only the AC adaptor, noted on page 3.
- The unit will not work during a power failure. We therefore recommend you also connect a standard telephone to the same telephone line using a T-adaptor. Your Panasonic sales shop can offer you more information about connection possibilities.

Battery installation

- 1 Insert the batteries negative (-) terminal first.

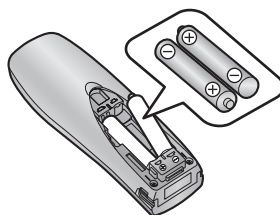

- 2 Close the battery cover.

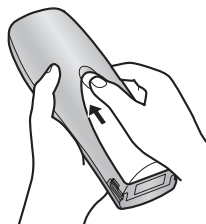

Note:

- Use only rechargeable batteries (page 3).

Battery charge

Place the handset on the base unit for about 7 hours before initial use.

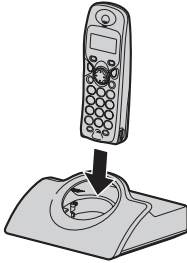



Note:



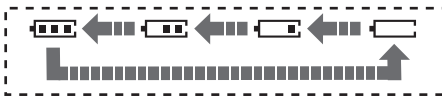

- Clean the charge contacts of the handset and base unit with a soft, dry cloth once a month, otherwise the batteries may not charge properly. Clean more often if the unit is exposed to grease, dust or high humidity.

Battery strength

When charging, the battery icon is shown as follows.



- When the batteries are fully charged,  flashes.

Battery icons	Battery strength
	High
	Medium
	Low
	Needs to be charged

Note:

- If the handset is turned off, it will be turned on automatically when it is placed on the base unit.

Battery life

After your Panasonic batteries are fully charged, you can expect the following performance:

Ni-MH batteries (typical 700 mAh)

Operation	Operating time
While in use (talking)	10 hours max.
While not in use (standby)	120 hours max.

Ni-Cd batteries (typical 250 mAh)

Operation	Operating time
While in use (talking)	4 hours max.
While not in use (standby)	40 hours max.

Note:

- The included batteries are Ni-MH batteries.
- Battery operating time may be shortened depending on usage conditions and ambient temperature.

Battery replacement

If  flashes even when the handset batteries have been fully charged, both batteries must be replaced.

Important:

- Please use only the Panasonic batteries, noted on page 3.
 - Use only rechargeable batteries. If you install non-rechargeable batteries and start charging, the batteries may leak electrolyte.
 - Do not mix old and new batteries.
 - Use only 2 nickel metal hydride (Ni-MH) batteries or 2 nickel cadmium (Ni-Cd) batteries. Do not mix battery types.
 - Ensure that the correct battery type is selected (page 19).
- 1 Press the notch on the cover firmly and slide it in the direction of the arrow.

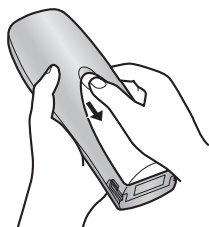

- 2 Remove the batteries positive (+) terminal first. Replace both batteries. See the battery installation on page 6.

Turning the power on/off

Power on

Press  for about 1 second.

- The display will change to the standby mode.

Power off

Press  for about 2 seconds.



- The display will go blank.

Setting the time and date

Important:

- Confirm that the AC adaptor is connected.
- Ensure that  is not flashing.





- 1 Press .

- 2 Press  repeatedly to display "SETTING BS", then press .

- 3 Press .

- 4 Enter the current hour and minute by selecting 2 digits for each (24-hour time entry).



Example: 15:15

Press  .

- If you make a mistake, press .
Digits will be cleared from the right.

- 5 Press .

- "SETTING BS" will be displayed.

- 6 Press , then press  2 times.

- 7 Enter the current day, month and year by selecting 2 digits for each.

Example: 17 May, 2004

Press   .

- If you make a mistake, press .
Digits will be cleared from the right.

- 8 Press .

- "SETTING BS" will be displayed.

- 9 Press .

Note:

- If a power failure occurs, set the time and date again.

Making calls

- 1 Lift the handset and dial the phone number.
 - To correct a digit, press [C], then enter the correct number.
- 2 Press [↶].
- 3 When finished talking, press [✕⊙] or place the handset on the base unit.

To adjust the receiver volume

You can select the desired receiver volume from level 1 to 3.

While talking, press [▲] or [▼].

Redial feature

To redial the last number dialled

Press [↶], then press [●].

To make a call using the redial list

The last 10 phone numbers dialled are stored in the redial list.

- 1 Press [●].
 - The last number dialled will be displayed.
- 2 Press [▼] repeatedly to select the number.
 - To exit the list, press [✕⊙].
- 3 Press [↶].

To edit a number in the redial list before calling it

- 1 Press [●].
- 2 Press [▼] repeatedly to select the number, then press [▶].
- 3 Press [▼] repeatedly to display "EDIT CALL NO", then press [▶].
 - The first digit of the number will flash.
- 4 Press [◀] or [▶] to move the cursor to

the right of where you want to edit the number.

- 5 Edit the number.
 - To erase a digit, press [C].
- 6 Press [↶].

To erase numbers in the redial list

- 1 Press [●].
- 2 Press [▼] repeatedly to select the number, then press [▶].
- 3 Press [▼] repeatedly to display "CLEAR", then press [▶].
 - If you want to erase all numbers in the list, select "ALL CLEAR".
- 4 Press [▼] repeatedly to display "YES", then press [▶].
 - To erase other numbers, repeat from step 2.
- 5 Press [✕⊙].

To store a number from the redial list into the phonebook

- 1 Press [●].
- 2 Press [▼] repeatedly to select the number, then press [▶].
- 3 Press [▼] repeatedly to display "SAVE TEL NO", then press [▶].
- 4 Press [☰].
- 5 Enter the name (9 characters max.; see the character table on page 11).
- 6 Press [☰].

Other features

Key lock

The dial keys can be locked so that no calls can be made. Only incoming calls will be accepted while key lock is on.

To turn on key lock, press [☰] for about 2 seconds.

- A beep will sound and the following will be

Telephone

displayed.

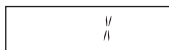

To turn off key lock, press [📠] for about 2 seconds.

Note:

- Emergency calls cannot be made until key lock is turned off.
- Key lock is turned off when the handset is turned off.

R button (to use the recall feature)

[R] is used to access optional telephone services. Contact your service provider for details.

If your unit is connected to a PBX (private branch exchange), pressing [R] can allow you to access certain features of your host PBX such as transferring an extension call.

Pause button (for PBX line/long distance service users)

A pause is sometimes required when making calls using a PBX or long distance service.

Example: If you have to dial [9] before dialling outside numbers manually, you will probably pause after dialling [9] until you hear a dial tone.

- 1 Press [9].
- 2 Press [⏸].
 - “P” will be displayed.
- 3 Dial the phone number.
- 4 Press [📞].

Note:

- Pressing [⏸] once creates one pause. Press [⏸] repeatedly to create longer pauses. To change pause length, see page 21.

Answering calls

- 1 Lift the handset and press [📞] when the unit rings.
 - You can also answer a call by pressing any dial key from [0] to [9], [✳], [##], or [INT]. (**Any key talk feature**)
- 2 When finished talking, press [📞] or place the handset on the base unit.

Auto talk feature

You can answer calls simply by lifting the handset off the base unit. You do not need to press [📞]. To turn this feature on, see page 19.

To turn the handset ringer off temporarily

When an outside call comes in, press and hold [▼] for about 1 second.

Note:

- This feature will not work for intercom calls or when the handset is on the base unit.

Handset locator

Using this feature, you can locate the handset if it has been misplaced.

- 1 Press [📞] on the left side of the base unit.
 - The base unit will page the handset for about 1 minute.
- 2 To stop paging, press [📞] on the base unit or press [📞] on the handset.

Phonebook

Storing phone numbers and names

Up to 20 phone numbers can be stored in the phonebook for quick access.

- 1 Press **[☰]** 2 times.
- 2 Enter a phone number (24 digits max.).
 - Each number stored in the phonebook will be given an index number (01–20). This number will be shown to the left of the stored phone number.
- 3 Press **[☰]**.
- 4 Enter the party's name (9 characters max.; see the character table).
- 5 Press **[☰]**.
 - To store other entries, repeat from step 2.
- 6 Press **[✕⊙]**.

Character table

Keys	Characters
[1]	# [] * , - / 1
[2]	A B C 2
[3]	D E F 3
[4]	G H I 4
[5]	J K L 5
[6]	M N O 6
[7]	P Q R S 7
[8]	T U V 8
[9]	W X Y Z 9
[0]	(Space) 0

Note:

- To enter another character located on the same dial key, press **[▶]** to move the cursor to the next space.

- If there is no space to store new entries, "MEMORY FULL" will be displayed. Erase unnecessary entries.

To edit/correct a mistake

- 1 Press **[◀]** or **[▶]** to move the cursor to the right of where you want to correct the number/character.
- 2 Press **[C]** to erase a digit, then enter the correct number/character.

Editing a stored entry

- 1 Press **[☐☐]**.
- 2 Press **[▲]** or **[▼]** repeatedly to display the desired entry, then press **[▶]**.
- 3 Press **[▼]** repeatedly to display "EDIT", then press **[▶]**.
 - If you do not need to edit the phone number, skip to step 5.
- 4 Edit the phone number.
- 5 Press **[☰]**.
 - If you do not need to edit the name, skip to step 7.
- 6 Edit the name. See the character table.
- 7 Press **[☰]**.

Erasing a stored entry

- 1 Press **[☐☐]**.
- 2 Press **[▲]** or **[▼]** repeatedly to display the desired entry, then press **[▶]**.
- 3 Press **[▼]** repeatedly to display "CLEAR", then press **[▶]**.
- 4 Press **[▼]** repeatedly to display "YES", then press **[▶]**.
 - To cancel erasing, select "NO".
 - To erase other entries, repeat from step 2.
- 5 Press **[✕⊙]**.

Making calls using the phonebook

Before using this feature, store the desired phone numbers and names into the phonebook (page 11).

- 1 Press [□□].
- 2 Press [▲] or [▼] repeatedly to display the desired entry.
- 3 Press [↶].

Hot key (quick dial)

Assigning an entry in the phonebook to a hot key

Dial keys [1] to [9] can each be used as a “hot key”, allowing you to dial a number from the phonebook by simply pressing a dial key.

- 1 Press [□□].
- 2 Press [▲] or [▼] repeatedly to display the desired entry, then press [▶].
- 3 Press [▼] repeatedly to display “HOT KEY REG”, then press [▶].
- 4 Press [▼] repeatedly to select the desired dial key ([1] to [9]), then press [▶].
 - If the dial key is already assigned as a hot key, the displayed number will flash.
- 5 Press [▼] repeatedly to display “YES”, then press [▶].
 - To register other entries, repeat from step 2.
- 6 Press [↶⊙].

Erasing a hot key

- 1 Press and hold the desired hot key ([1] to [9]), then press [▶].
 - “CLEAR” will be displayed.

- 2 Press [▶].
- 3 Press [▼] repeatedly to display “YES”, then press [▶].
- 4 Press [↶⊙].

Note:

- The number erased from a hot key will not be deleted from the phonebook. To erase from the phonebook, see page 11.

Making calls using a hot key

- 1 Press and hold the desired hot key ([1] to [9]).
 - You can view other hot key registrations by pressing [▲] or [▼].
- 2 Press [↶].

Caller ID service

Important:

- This unit is Caller ID compatible. To display the caller's phone number, you must subscribe to Caller ID service. After subscribing to Caller ID service, this unit will display caller information.

How Caller ID is displayed

The unit will display the calling party's phone number after the first ring. You can view the caller information of the last 50 different callers.

When new calls have been received, the display will show the number of new calls.

Example: 4 new calls have been received.

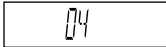

- The number of new calls will be cleared after viewing all caller information.

Note:

- When you receive a call from the same phone number you stored with a name in the phonebook, the display will show the stored name.
- If the unit is connected to a PBX system, you may not receive the caller information.
- When the caller dialled from an area which does not provide Caller ID service, "OUT OF AREA" will be displayed.
- When the caller requested not to send caller information, either no information or "PRIVATE" will be displayed.
- The display will not show caller information while using the handset for an intercom call. However, the caller information will be stored.

Visual call waiting (Call Waiting ID) service

This is a service of your service provider and will only operate if you have subscribed to

this service. When you hear a call waiting tone during a conversation, the display will show the second caller's information. You can answer the second call, keeping the first call on hold. Please consult your service provider for details of this service.

Viewing caller information and calling back

The unit will automatically store the phone numbers of the last 50 different callers from the most recent call to the oldest. When the 51st call is received, the oldest caller information will be automatically erased.

You can easily view caller information and use it to make calls.

- 1 Press [▼].
- 2 Press [▼] repeatedly to search from the most recent caller information.

Example:

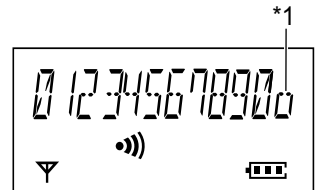

*1 Shown when this call has already been viewed or answered.

- 3 Press [↶] to call back the displayed party.

Note:

- When no calls have been received, the display will show "NO ITEM".

Editing a caller's phone number before calling back

- 1 Press [▲] or [▼] repeatedly to display the desired entry, then press [▶].
- 2 Press [▼] repeatedly to display "EDIT CALL NO", then press [▶].
- 3 Press [◀] or [▶] to move the cursor to

Telephone

the right of where you want to edit the number.

- 4 Edit the phone number.
 - To erase a digit, press **[C]**.

- 5 Press **[↶]**.

Note:

- The edited phone number will not be saved.

Erasing caller information

- 1 Press **[▲]** or **[▼]** repeatedly to display the desired entry, then press **[▶]**.
- 2 Press **[▼]** repeatedly to display "CLEAR", then press **[▶]**.
 - If you want to erase all caller information, select "ALL CLEAR".
- 3 Press **[▼]** repeatedly to display "YES", then press **[▶]**.
- 4 Press **[✕⊙]**.

Storing caller information into the phonebook

- 1 Press **[▲]** or **[▼]** repeatedly to display the desired entry, then press **[▶]**.
- 2 Press **[▼]** repeatedly to display "SAVE TEL NO", then press **[▶]**.
- 3 Press **[☰]**.
- 4 Enter the party's name (9 characters max.; see the character table on page 11).
- 5 Press **[☰]**.
- 6 Press **[✕⊙]**.

Guide to handset settings

For your reference, a chart of all items which can be customised for the handset is printed below. Details of each item can be found on the corresponding pages.

To enter the 2nd menu, first press [▶]. Press [▼] repeatedly to display "SETTING HS", then press [▶].

2nd menu	3rd menu	Default setting	Page
"TIME ALARM"	"SET TIME"	_____	page 16
	"SET ALARM"	"OFF"	page 16
"RINGER OPT" (Ringer options)	"RINGER VOL" (Ringer volume)	Level 6	page 16
	"EXT RINGER" (External ringer)	"RING TYPE 1"	page 16
	"INT RINGER" (Internal ringer)	"RING TYPE 1"	page 16
	"PAGING"	"RING TYPE 1"	page 16
	"ALARM"	"RING TYPE 1"	page 16
"TONE OPT" (Tone options)	"KEY TONE"	"ON"	page 17
	"CALL WAITING"	"ON"	page 17
	"RANGE ALARM"	"OFF"	page 17
	"BATTERY LOW"	"ON"	page 17
"DISPLAY OPT" (Display options)	"STANDBY MODE"	"CLOCK"	page 17
	"TALK MODE"	"TALK TIME"	page 17
	"LANGUAGE"	"ENGLISH"	page 18
"CALL OPT" (Call options)	"CALL BAR"	"OFF"	page 18
	"DIRECT NO" (Direct number)	_____	page 18
	"SET DIRECT"	"OFF"	page 19
"OTHER OPT" (Other options)	"HSPIN CHANGE" (Handset PIN change)	"0000"	page 19
	"AUTO TALK"	"OFF"	page 19
	"BATTERY TYPE"	"NI-MH"	page 19
"REGISTRATION"	"REGISTER HS" (Register handset)	_____	page 23
	"CANCEL BS"*1 (Cancel base unit)	_____	page 24
"SELECT BS" (Select base unit)	_____	"AUTO"	page 24
"RESET HS" (Reset handset)	_____	_____	page 19

*1 If you cancel a base unit, the handset will "forget" the base unit registration.

Handset settings

Time alarm

An alarm will sound for 3 minutes at the set time once or daily.

“ONCE”: The alarm will ring only once.

“REPEAT DAILY”: The alarm will ring at the set time everyday.

“OFF”: Turns this feature off.

Set the time and date beforehand (page 8).

Setting the time of alarm

- 1 Press [≡].
- 2 Press [▼] repeatedly to display “SETTING HS”, then press [▶].
- 3 Press [▼] repeatedly to display “TIME ALARM”, then press [▶].
- 4 Press [▼] repeatedly to display “SET TIME”, then press [▶].
- 5 Enter the desired hour and minute by selecting 2 digits for each (24-hour time entry).
 - To erase a digit, press [C].
- 6 Press [▶].
- 7 Press [▼] repeatedly to select the desired setting, then press [▶].
- 8 Press [⊗⊙].

Note:

- To stop the alarm, press any dial key.
- When in talk or intercom mode, the alarm will not sound until the call has ended.
- If you select “ONCE”, the setting will be changed to “OFF” after the alarm rings.

Changing the alarm frequency

- 1 Press [≡].
- 2 Press [▼] repeatedly to display “SETTING HS”, then press [▶].
- 3 Press [▼] repeatedly to display “TIME

ALARM”, then press [▶].

- 4 Press [▼] repeatedly to display “SET ALARM”, then press [▶].
- 5 Press [▼] repeatedly to select the desired setting, then press [▶].
- 6 Press [⊗⊙].

Ringer options

Ringer volume

You can select the desired ringer volume from off, level 1 to 6 or *6.

- 1 Press [≡].
- 2 Press [▼] repeatedly to display “SETTING HS”, then press [▶].
- 3 Press [▼] repeatedly to display “RINGER OPT”, then press [▶].
- 4 Press [▼] repeatedly to display “RINGER VOL”, then press [▶].
- 5 Press [▲] or [▼] repeatedly to select the desired volume, then press [▶].
- 6 Press [⊗⊙].

Note:

- If you set to level 3 to 6 or *6, each ringer will start ringing with lower volume, then gradually increase in volume when receiving a call.
- Levels 6 and *6 are the highest settings. Their ringing methods are slightly different.
- When the ringer volume is set to off, the following will be displayed.

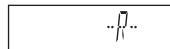

Ringer types for external calls, internal calls, paging or alarm

There are 20 ringer types (6 ringers and 14 melody ringers) available for each item.

“EXT RINGER”: For external calls

“INT RINGER”: For internal calls

“PAGING”: For paging

“ALARM”: For alarm

- 1 Press **[☰]**.
- 2 Press **[▼]** repeatedly to display “SETTING HS”, then press **[▶]**.
- 3 Press **[▼]** repeatedly to display “RINGER OPT”, then press **[▶]**.
- 4 Press **[▼]** repeatedly to display the desired item, then press **[▶]**.
- 5 Press **[▼]** repeatedly to select the desired setting from “RING TYPE 1” to “RING TYPE 20”, then press **[▶]**.
- 6 Press **[✕⊙]**.

Note:

- If you select one of the melody ringer types, the ringer will continue to sound for several seconds if the caller hangs up before you answer. You may hear a dial tone or no one on the line when you answer a call.

Tone options

You can turn the following tones and alarms on or off.

“KEY TONE”: Tones heard when keys are pressed. Includes confirmation tones and error tones.

“CALL WAITING”: Tones heard when an outside call is received while on an intercom call.

“RANGE ALARM”: An alarm heard when you move out of range of a base unit during a conversation.

“BATTERY LOW”: An alarm heard when the batteries need to be charged.

- 1 Press **[☰]**.
- 2 Press **[▼]** repeatedly to display “SETTING HS”, then press **[▶]**.
- 3 Press **[▼]** repeatedly to display “TONE OPT”, then press **[▶]**.
- 4 Press **[▼]** repeatedly to display the desired item, then press **[▶]**.
- 5 Press **[▼]** repeatedly to select “ON” or

“OFF”, then press **[▶]**.

- 6 Press **[✕⊙]**.

Display options

Selecting the standby mode display

“CLOCK”: The time and date will be displayed. Set the time and date beforehand (page 8).

“OFF”: Turns this feature off.

“BS NO”: The base unit number will be displayed.

“HS NO”: The handset number will be displayed.

- 1 Press **[☰]**.
- 2 Press **[▼]** repeatedly to display “SETTING HS”, then press **[▶]**.
- 3 Press **[▼]** repeatedly to display “DISPLAY OPT”, then press **[▶]**.
- 4 Press **[▼]** repeatedly to display “STANDBY MODE”, then press **[▶]**.
- 5 Press **[▼]** repeatedly to select the desired setting, then press **[▶]**.
- 6 Press **[✕⊙]**.

Note:

- If you subscribe to a Caller ID service, the display will show the number of new calls even if “CLOCK” has been selected (page 13).

- If “BS NO” is selected, the base unit number will be displayed.

Example:



- If “HS NO” is selected, the handset number will be displayed.

Example:













Selecting the talk mode display

“TALK TIME”: The length of the current call will be displayed.











Useful Telephone Settings

“PHONE NO”: The phone number will be displayed.

- 1 Press .
- 2 Press  repeatedly to display “SETTING HS”, then press .
- 3 Press  repeatedly to display “DISPLAY OPT”, then press .
- 4 Press  repeatedly to display “TALK MODE”, then press .
- 5 Press  repeatedly to select the desired setting, then press .
- 6 Press  .

Selecting the display language

10 display languages are available.

- 1 Press .
- 2 Press  repeatedly to display “SETTING HS”, then press .
- 3 Press  repeatedly to display “DISPLAY OPT”, then press .
- 4 Press  repeatedly to display “LANGUAGE”, then press .
- 5 Press  repeatedly to select the desired language, then press .
- 6 Press  .



Note:









- If you select a language you cannot read, reset the handset to its default settings (page 19).

Call options

Setting call bar

This feature prohibits making outside calls. When call bar is turned on, only intercom calls and emergency calls can be made. To store emergency numbers, see page 22.

- 1 Press .
- 2 Press  repeatedly to display “SETTING HS”, then press .

- 3 Press  repeatedly to display “CALL OPT”, then press .
- 4 Press  repeatedly to display “CALL BAR”, then press .
- 5 Enter “0000” (default handset PIN).
 - If you changed PIN, enter it (page 19).
- 6 Press  repeatedly to select “ON” or “OFF”, then press .
- 7 Press  .











Note:

- While this feature is turned on, the following will be displayed.



Storing the direct call number

Direct call allows you to dial a preset phone number simply by pressing . No dialling is necessary.

- 1 Press .
- 2 Press  repeatedly to display “SETTING HS”, then press .
- 3 Press  repeatedly to display “CALL OPT”, then press .
- 4 Press  repeatedly to display “DIRECT NO”, then press .
- 5 Enter a phone number (24 digits max.).
 - To correct a mistake, press **[C]**. Digits are cleared from the right.
- 6 Press  2 times.
- 7 Press  to select “ON”, then press  .

Note:

- When this feature is turned on, only the direct call number can be called.
- While this feature is turned on, the following will be displayed.



Turning direct call on/off

- 1 Press [≡].
 - 2 Press [▼] repeatedly to display "SETTING HS", then press [▶].
 - 3 Press [▼] repeatedly to display "CALL OPT", then press [▶].
 - 4 Press [▼] repeatedly to display "SET DIRECT", then press [▶].
 - 5 Press [▼] repeatedly to select "ON" or "OFF", then press [▶].
 - 6 Press [✕⊙].
-

Other options**Changing the handset PIN (Personal Identification Number)**

The handset's default PIN is "0000".

Important:

- If you change the PIN, please write down your new PIN as the unit will not reveal the PIN to you. If you forget your PIN, consult your nearest Panasonic service centre.

- 1 Press [≡].
 - 2 Press [▼] repeatedly to display "SETTING HS", then press [▶].
 - 3 Press [▼] repeatedly to display "OTHER OPT", then press [▶].
 - 4 Press [▼] repeatedly to display "HSPIN CHANGE", then press [▶].
 - 5 Enter the current 4-digit handset PIN.
 - 6 Enter the new 4-digit handset PIN.
 - 7 Enter the new 4-digit handset PIN again.
 - 8 Press [✕⊙].
-

Setting auto talk

This feature allows you to answer calls simply by lifting the handset off the base unit. You do not need to press [↶].

- 1 Press [≡].

- 2 Press [▼] repeatedly to display "SETTING HS", then press [▶].
 - 3 Press [▼] repeatedly to display "OTHER OPT", then press [▶].
 - 4 Press [▼] repeatedly to display "AUTO TALK", then press [▶].
 - 5 Press [▼] repeatedly to select "ON" or "OFF", then press [▶].
 - 6 Press [✕⊙].
-

Setting the battery type

"NI-MH": Select when nickel metal hydride batteries are installed.

"NI-CD": Select when nickel cadmium batteries are installed.

- 1 Press [≡].
 - 2 Press [▼] repeatedly to display "SETTING HS", then press [▶].
 - 3 Press [▼] repeatedly to display "OTHER OPT", then press [▶].
 - 4 Press [▼] repeatedly to display "BATTERY TYPE", then press [▶].
 - 5 Press [▼] repeatedly to select the desired setting, then press [▶].
 - 6 Press [✕⊙].
-

Resetting the handset to its default settings

- 1 Press [≡], [▼], [▶], [▲] and [▶].
- 2 Enter "0000" (default handset PIN).
 - If you changed PIN, enter it (page 19).
- 3 Press [▼], [▶] and [✕⊙].

Note:

- For the default settings, see page 15.
- Phonebook entries will not be erased.
- The battery type setting will not be reset.

Guide to base unit settings

For your reference, a chart of all items which can be customised for the base unit is printed below. Details of each item can be found on the corresponding pages.

Code No.	Feature (Default setting)	Page
[0]	Reset base unit	page 22
[1]	Set all or selected handsets to ring (All handsets ring)	page 25
[2]	Base unit ringer volume (Medium)	page 20
[3]	Time break recall or earth recall (Time break recall)	page 20
	Pause length (3 seconds)	page 21
[5]	Change base unit PIN ("0000")	page 20
[6]	Call restriction	page 21
	Emergency number ("112" and "999")	page 22
[7]	Cancel a handset* ¹	page 24
[*]	Time and date	page 8

*1 If you cancel a handset, the base unit will "forget" the handset registration.

Base unit settings

Changing base unit PIN (Personal Identification Number)

The base unit's default PIN is "0000".

Important:

- If you change the PIN, please write down your new PIN as the unit will not reveal the PIN to you. If you forget your PIN, consult your nearest Panasonic service centre.

- 1 Press [M].
- 2 Press [▼] repeatedly to display "SETTING BS", then press [▶].
- 3 Press [5].
- 4 Enter the current 4-digit base unit PIN.
- 5 Enter the new 4-digit base unit PIN.
- 6 Enter the new 4-digit base unit PIN again.
- 7 Press [✕⊙].

Adjusting ringer volume

4 levels (high/medium/low/off) are available.

- 1 Press [M].
- 2 Press [▼] repeatedly to display "SETTING BS", then press [▶].
- 3 Press [2] 2 times.
- 4 Select the desired setting by pressing [1] for low, [2] for medium, [3] for high or [0] for off.
- 5 Press [▶], then press [✕⊙].

Setting time break/earth recall

Select either time break recall or earth recall to suit your PBX or service provider. If you select earth recall, an earth relay must be installed. For further information, consult your nearest Panasonic service centre.

- 1 Press [M].

- 2 Press [▼] repeatedly to display "SETTING BS", then press [▶].
- 3 Press [3].
- 4 Enter "0000" (default base unit PIN).
 - If you changed PIN, enter it (page 20).
- 5 Press [2].
- 6 Select the desired setting by pressing [1] for time break recall or [2] for earth recall.
 - If you select time break recall, "1-2" will be displayed and it shows 80 ms.
- 7 Press [▶], then press [✕⊙].

Setting pause length

- 1 Press [≡].
- 2 Press [▼] repeatedly to display "SETTING BS", then press [▶].
- 3 Press [3].
- 4 Enter "0000" (default base unit PIN).
 - If you changed PIN, enter it (page 20).
- 5 Press [3].
- 6 Select the desired setting by pressing [1] for 3 seconds or [2] for 5 seconds.
- 7 Press [▶], then press [✕⊙].

Setting call restriction

You can restrict selected handsets from dialling certain phone numbers. You can assign up to 10 phone numbers (memory locations 1-10) to be restricted per handset. If a restricted number is dialled, the call will not be connected and the restricted number will flash on the display. For example, storing an area code will prevent a handset from dialling a long distance call.

- 1 Press [≡].
- 2 Press [▼] repeatedly to display "SETTING BS", then press [▶].
- 3 Press [6].

- 4 Enter "0000" (default base unit PIN).
 - If you changed PIN, enter it (page 20).
 - All the registered handset numbers will be displayed.
 - Flashing numbers indicate call restriction is turned on for the corresponding handset.
- 5 Press the desired handset numbers.
 - The selected handset numbers will flash.
 - To cancel a selected handset number, press the number again. The number will stop flashing.
- 6 Press [▶].
- 7 Enter the phone number to be restricted (8 digits max.).
 - If you enter a number when a previously stored number is already displayed, the new number will erase the old number.
 - To select a different memory location, press [▶] repeatedly and enter a number.
- 8 Press [▶].
- 9 Press [✕⊙].

Turning on/off call restriction

- 1 Press [≡].
- 2 Press [▼] repeatedly to display "SETTING BS", then press [▶].
- 3 Press [6].
- 4 Enter "0000" (default base unit PIN).
 - If you changed PIN, enter it (page 20).
 - Handset numbers will be displayed. Flashing numbers indicate call restriction is on; non-flashing numbers indicate call restriction is off.
- 5 Press the desired handset numbers to turn on/off.
- 6 Press [▶], then press [✕⊙].

Canceling a restricted number

- 1 Press **[☰]**.
- 2 Press **[▼]** repeatedly to display “SETTING BS”, then press **[▶]**.
- 3 Press **[6]**.
- 4 Enter “0000” (default base unit PIN).
 - If you changed PIN, enter it (page 20).
- 5 Press **[▶]** repeatedly to display the desired number.
- 6 Press **[C]**.
- 7 Press **[▶]**, then press **[✕⊙]**.

Storing emergency numbers

This feature determines which phone numbers may be dialled while the call bar feature is turned on. A total of 4 emergency numbers (memory locations 1–4) can be stored.

- 1 Press **[☰]**.
- 2 Press **[▼]** repeatedly to display “SETTING BS”, then press **[▶]**.
- 3 Press **[6]**.
- 4 Enter “0000” (default base unit PIN).
 - If you changed PIN, enter it (page 20).
- 5 Press **[✕]**.
- 6 Enter the emergency number (8 digits max.).
 - If you enter a number when an emergency number is already displayed, the new number will erase the old number.
 - To select a different memory location, press **[▶]** repeatedly and enter a number.
- 7 Press **[▶]**.
- 8 Press **[✕⊙]**.

Changing stored emergency numbers

- 1 Press **[☰]**.

- 2 Press **[▼]** repeatedly to display “SETTING BS”, then press **[▶]**.
- 3 Press **[6]**.
- 4 Enter “0000” (default base unit PIN).
 - If you changed PIN, enter it (page 20).
- 5 Press **[✕]**.
- 6 Press **[▶]** repeatedly to display the desired number.
- 7 Press **[C]** and enter the new emergency number.
- 8 Press **[▶]**.
- 9 Press **[✕⊙]**.

Resetting the base unit to its default settings

- 1 Press **[☰]**.
- 2 Press **[▼]** repeatedly to display “SETTING BS”, then press **[▶]**.
- 3 Press **[0]**.
- 4 Enter “0000” (default base unit PIN).
 - If you changed PIN, enter it (page 20).
- 5 Press **[▶]**, then press **[✕⊙]**.

Note:

- For the default settings, see page 20.
- The emergency number setting will not be reset.

Operating additional units

Additional handsets

Up to 6 handsets can be registered to a single base unit. Additional handsets will give you the freedom to, for example, have an intercom call with another handset while a third handset is on an outside call. See page 3 for information on ordering additional handsets.

Additional base units

Handsets can be registered to up to 4 base units, allowing you to add additional base units and extend the area in which your handset(s) can be used. If a handset moves out of range of its base unit when "AUTO" is selected on base unit selection (page 24), it will look for another base unit to make or receive calls. A base unit and the handsets it communicates with is called a "radio cell".

Note:

- Calls will be disconnected when the handset moves from one radio cell to another.
- Intercom calls and call transfers are only possible between handsets in the same radio cell.

Registering a handset to a base unit

To register an additional handset to a base unit (easy registration)

The included handset and base unit are preregistered. After purchasing an additional handset, register it to the base unit using the following method.

- 1 Lift the additional handset and press **[✕⊙]**.

- 2 Press and hold **[📞]** on the left side of the base unit for about 5 seconds, until the registration tone sounds.
- 3 Place the additional handset on the base unit. The registration tone continues to sound. With the handset still on the base unit, wait until a confirmation tone sounds and **Y** stops flashing.

Note:

- If an error tone sounds, or if **Y** is still flashing, register the handset manually (manual registration).
- If all registered handsets start ringing in step 2, press **[📞]** to stop, then start again.
- Charge the batteries of your additional handset for about 7 hours before initial use.

To register a handset to an additional base unit (manual registration)

You can register a handset to a base unit manually using the following method.

- 1 Press **[☰]**.
- 2 Press **[▼]** repeatedly to display "SETTING HS", then press **[▶]**.
- 3 Press **[▼]** repeatedly to display "REGISTRATION", then press **[▶]**.
- 4 Press **[▼]** repeatedly to display "REGISTER HS", then press **[▶]**.
- 5 Press and hold **[📞]** on the left side of the base unit for about 5 seconds, until the registration tone sounds.
 - After pressing **[📞]**, the rest of the procedure must be completed within 1 minute.
- 6 Press **[▼]** repeatedly to select a base unit number, then press **[▶]**.
- 7 Wait until "BS PIN" is displayed, then enter "0000" (default base unit PIN).
 - If you changed PIN, enter it (page 20).
- 8 Press **[▶]**.
 - When the handset has been registered

successfully, a confirmation tone will sound, and ∇ will stop flashing.

Note:

- If all registered handsets start ringing in step 5, press **[Ⓜ]** to stop, then start again from step 1.

Selecting a base unit

When "AUTO" is selected, the handset will automatically use any available base unit it is registered to. When a specific base unit is selected, the handset will make and receive calls using that base unit only. If the handset is out of range of that base unit, no calls can be made.

- 1 Press **[☰]**.
- 2 Press **[▼]** repeatedly to display "SETTING HS", then press **[▶]**.
- 3 Press **[▼]** repeatedly to display "SELECT BS", then press **[▶]**.
- 4 Press **[▼]** repeatedly to display "AUTO" or a specific base unit number, then press **[▶]**.
 - The handset starts searching for the base unit.

Note:

- When a handset is registered to another base unit, this setting will automatically change to that base unit's number even if "AUTO" was selected.

Cancelling a handset

A maximum of 6 handsets can be registered to a base unit. A handset can cancel its own registration (or the registration of another handset) that is stored in the base unit. This will allow the base unit to "forget" the handset.

- 1 Press **[☰]**.
- 2 Press **[▼]** repeatedly to display "SETTING BS", then press **[▶]**.
- 3 Press **[7]**.

- 4 Enter "0000" (default base unit PIN).
 - If you changed PIN, enter it (page 20).
- 5 Press the desired handset number.
 - The selected handset number will flash.
- 6 Press **[▶]**.
- 7 Wait until "SETTING BS" is displayed, then press **[✕Ⓞ]**.

Cancelling a base unit

A handset can be registered to a maximum of 4 base units. A handset can cancel a base unit that it is registered to. This will allow the handset to "forget" that base unit.

- 1 Press **[☰]**.
- 2 Press **[▼]** repeatedly to display "SETTING HS", then press **[▶]**.
- 3 Press **[▼]** repeatedly to display "REGISTRATION", then press **[▶]**.
- 4 Press **[▼]** repeatedly to display "CANCEL BS", then press **[▶]**.
- 5 Enter "0000" (default handset PIN).
 - If you changed PIN, enter it (page 19).
- 6 Press **[▼]** repeatedly to select the desired base unit number, then press **[▶]**.
 - The selected base unit number will flash.
- 7 Press **[▶]**.
- 8 Press **[▼]** repeatedly to select "YES", then press **[▶]**.
 - To stop cancelling, select "NO".
- 9 Press **[✕Ⓞ]**.

Note:

- To register the handset to another base unit or to the same base unit again, see manual registration (page 23).

Setting all or selected handsets to ring

You can select one of 3 methods to determine how the handsets ring for incoming calls.

- “1”: All handsets will ring.
- “2”: Selected handset(s) will ring.
- “3”: Selected handset(s) will ring, then all handsets will ring.

Setting all handsets to ring

- 1 Press [≡].
- 2 Press [▼] repeatedly to display “SETTING BS”, then press [▶].
- 3 Press [1].
- 4 Enter “0000” (default base unit PIN).
 - If you changed PIN, enter it (page 20).
- 5 Press [1] to select “1”.
- 6 Press [▶], then press [✕⊙].

Setting the selected handset(s) to ring

- 1 Press [≡].
- 2 Press [▼] repeatedly to display “SETTING BS”, then press [▶].
- 3 Press [1].
- 4 Enter “0000” (default base unit PIN).
 - If you changed PIN, enter it (page 20).
- 5 Press [2] to select “2”.
 - All registered handset numbers will be displayed and the pre-selected handset number will flash.
- 6 Press the desired handset number(s).
 - The selected handset number(s) will flash.
 - To cancel a selected handset number, press the number again. The number will stop flashing.
- 7 Press [▶], then press [✕⊙].

Setting the selected handset(s) to ring before all handsets ring

- 1 Press [≡].
- 2 Press [▼] repeatedly to display “SETTING BS”, then press [▶].
- 3 Press [1].
- 4 Enter “0000” (default base unit PIN).
 - If you changed PIN, enter it (page 20).
- 5 Press [3] to select “3”.
 - All registered handset numbers will be displayed and the pre-selected handset number will flash.
- 6 Press the desired handset number(s).
 - The selected handset number(s) will flash.
 - To cancel a selected handset number, press the number again. The number will stop flashing.
- 7 Press [▶].
- 8 Press a dial key from [1] to [6] to select the number of rings before all handsets ring.
 - The selected number of rings will be shown on the right edge of the display.
- 9 Press [▶], then press [✕⊙].

Intercom between handsets

You can make intercom calls between 2 handsets in the same radio cell.

Example: When handset 1 calls handset 2

1 Handset 1:

Press **[INT]** and **[2]** (desired handset number).

2 Handset 2:

Press **[↶]** to answer.

3 When finished talking, press **[↵⊙]**.

Note:

- Intercom calls can be made between handsets in the same radio cell, but not between handsets in different radio cells.

Transferring calls between handsets/ Conference call

Outside calls can be transferred between 2 handsets in the same radio cell. 2 handsets in the same radio cell can have a conference call with an outside party.

Example: When handset 1 transfers a call to handset 2

1 Handset 1:

During an outside call, press **[INT]** and **[2]** (desired handset number).

- If there is no answer, press **[INT]** to return to the outside call.

2 Handset 2:

Press **[↶]** to answer the page.

- Handset 2 can talk with handset 1.
- The outside call will be put on hold.

3 Handset 1:

To complete the call transfer, press **[↵⊙]**.

To establish a conference call, press **[3]**.

To transfer a call directly without speaking to handset 2

After step 1, press **[↵⊙]** on handset 1.

If the transferred call is not answered within 30 seconds, handset 1 will ring again.

Troubleshooting

If you still have difficulties after following the instructions in this section, disconnect the AC adaptor and turn off the handset, then reconnect the AC adaptor and turn on the handset.

is flashing.

- The handset is not registered to the base unit. Register it (page 23).
- The handset is too far from the base unit. Move closer.
- The AC adaptor is not connected. Check the connections.

I cannot make or receive calls.

- The AC adaptor or telephone line cord is not connected. Check the connections.
- If you are using a splitter to connect the unit, remove the splitter and connect the unit to the wall socket directly. If the unit operates properly, check the splitter.
- Disconnect the base unit from the telephone line and connect the line to a known working telephone. If the working telephone operates properly, contact our service personnel to have the unit repaired. If the working telephone does not operate properly, contact your service provider.
- The call bar feature is turned on. Turn it off (page 18).
- You dialled a call restricted number (page 21).
- The key lock feature is on. Turn it off (page 9).

The unit does not ring.

- The ringer volume is turned off. Adjust the handset ringer volume (page 16) and the base unit ringer volume (page 20).

The handset display is blank.

- The handset is not turned on. Turn the

power on (page 8).

The handset will not turn on.

- Make sure that the batteries are installed correctly (page 6).
- Fully charge the batteries (page 7).
- Clean the charge contacts and charge again (page 7).

The battery should be charging but the battery icon does not change.

- Clean the charge contacts and charge again (page 7).
- The AC adaptor is disconnected. Plug in the AC adaptor.

A busy tone is heard when is pressed.

- The handset is too far from the base unit. Move closer and try again.
- Another handset is on an outside call. Wait for the other user to complete the call.

Static, sound cuts in/out, fades. Interference from other electrical units.

- Locate the handset and the base unit away from other electrical appliances.
- Move closer to the base unit.

The handset stops working while being used.

- Disconnect the AC adaptor and turn off the handset. Connect the AC adaptor, turn on the handset and try again.

While storing an entry in the phonebook or assigning a hot key, the handset starts to ring.

- A call is being received. To answer the call, press . Programming will be cancelled. Start again.

Pressing does not display/dial the last number dialled.

- If the redialled number was more than 24 digits long, the number will not be

Useful Information

redialled. Redial the number manually.

The handset beeps intermittently and/or flashes.

- Fully charge the batteries (page 7).

I fully charged the batteries, but still flashes.

- Clean the charge contacts and charge again (page 7).
- It is time to replace the batteries (page 8).

disappears and the unit stops charging when the handset is on the base unit.

- Nickel cadmium batteries are inserted when the battery type is set to “NI-MH”. Change the battery type setting to “NI-CD” (page 19).

Caller information is not displayed.

- You must subscribe to Caller ID service.

While viewing caller information, the display returns to standby mode.

- Do not pause for over 60 seconds while searching.

I cannot register a handset to a base unit.

- The maximum number of base units (4) are already registered to the handset. Cancel unused base unit registrations from the handset (page 24).
- The maximum number of handsets (6) are already registered to the base unit. Cancel unused handset registrations from the base unit (page 24).
- You entered the wrong PIN number. If you forget your PIN, consult your nearest Panasonic service centre.
- Locate the handset and the base unit away from other electrical appliances.

Technical information

Standard: DECT (Digital Enhanced Cordless Telecommunications), GAP (Generic Access Profile)

Number of channels: 120 Duplex Channels

Frequency range: 1.88 GHz to 1.9 GHz

Duplex procedure: TDMA (Time Division Multiple Access)

Channel spacing: 1728 kHz

Bit rate: 1152 kbit/s

Modulation: GFSK (Gaussian Frequency Shift Keying)

RF Transmission Power: Approx. 250 mW

Voice coding: ADPCM 32 kbit/s

Power source: AC adaptor 220–240 V, 50 Hz

Power consumption, Base unit: Standby: Approx. 3.5 W, Maximum: Approx. 9.2 W

Operating conditions: 5 °C–40 °C, 20 %–80 % relative air humidity (dry)

Dimensions, Base unit: Approx. 58 mm x 128 mm x 105 mm

Dimensions, Handset: Approx. 143 mm x 48 mm x 32 mm

Mass (weight), Base unit: Approx. 170 g

Mass (weight), Handset: Approx. 120 g

Note:

- Specifications are subject to change.
- The illustrations used in these operating instructions may differ slightly from the actual product.

Wall mounting

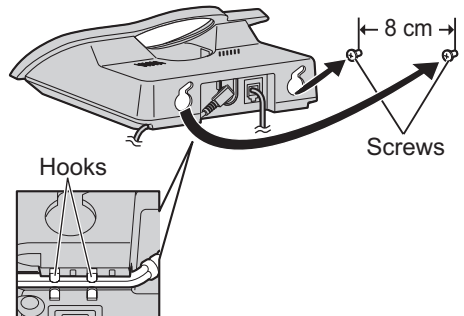

Note:

- Make sure the screws are securely fastened to the wall.
- Use the following wall template to position the screws before drilling.

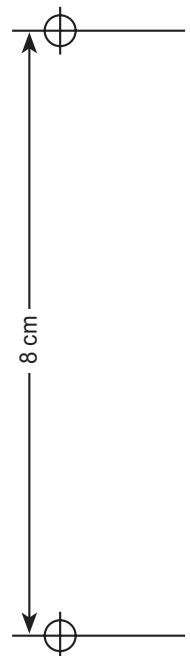

Conditions of guarantee

This guarantee is in addition to and does not in any way affect any statutory or other rights of consumer purchasers. If within the applicable guarantee period, the appliance proves to be defective by reason of faulty design, workmanship or materials, we undertake subject to the following conditions to have the defective appliance (or any part or parts thereof) repaired or replaced free of charge.

1. The appliance shall have been purchased and used solely within either the UK or ROI and in accordance with standard operating instructions and the technical and/or Safety Standards required in the UK.
2. The appliance should be returned together with this guarantee and proof of date of purchase promptly on being found defective at the purchaser's risk and expense to the authorised dealer from whom the appliance was purchased or to the nearest authorised dealer. All enquires must be through such dealers.
3. This guarantee shall not apply to damage caused through fire, accident, lightning, misuse, wear and tear, neglect, incorrect adjustment or repair, to damage caused through installation, adaption, modification or use in an improper manner or inconsistent with the technical and/or safety standards required in the country where this appliance is used, or to damage occurred during transit to or from the purchaser.
4. If at any time during the guarantee period any part or parts of the appliance are replaced with a part or parts not supplied or approved by us or of an objective quality safe and suitable for the appliance, or the appliance has been dismantled or repaired by any person not authorised by us, we shall have the right to terminate this guarantee in whole or in part immediately without further notice.
5. The purchaser's sole and exclusive remedy under this guarantee against us is for the repair or replacement of the appliance or any defective part or parts and no other remedy, including, but not limited to, incidental or consequential damage or loss of whatsoever nature shall be available to the purchaser.
6. This guarantee shall not apply to batteries and any other items of limited natural life.
7. Our decision on all matters relating to complaints shall be final. Any appliance or defective part which has been replaced shall become our property.
8. The guarantee period applicable to this product shall be 12 months.

Please keep these operating instructions with your receipt.

Panasonic Business Systems U.K.

Receipt No. _____	Date of purchase _____
Model No. _____	Serial No. _____

Index

- A** Additional base units: 23
 Additional handsets: 23
 All handsets to ring: 25
 Selected handsets to ring: 25
 Answering calls: 10
 Auto talk: 10
- B** Base unit
 Cancelling: 24
 Guide to settings: 20
 PIN: 20
 Resetting: 22
 Selecting: 24
 Battery
 Charge: 7
 Installation: 6
 Life: 7
 Replacement: 8
 Strength: 7
 Type: 19
 Battery low alarm: 17
- C** Call bar: 18
 Call restriction: 21
 Call transfer: 26
 Call waiting tone: 17
 Caller ID: 13
 Call waiting: 13
 Calling back: 13
 Editing: 13
 Erasing: 14
 Storing into phonebook: 14
 Viewing: 13
 Character table: 11
 Conference call: 26
 Connections: 6
- D** Direct call: 18
 Display
 Icons: 5
 Language: 18
 Standby mode: 17
 Talk mode: 17
- E** Earth recall: 20
 Emergency call: 22
- H** Handset
 Cancelling: 24
 Guide to settings: 15
 Locator: 10
 PIN: 19
 Power on/off: 8
 Resetting: 19
 Hot key (quick dial): 12
- I** Intercom: 26
- K** Key lock: 9
 Key tone: 17
- M** Making calls: 9
- P** Pause: 10
 Pause length: 21
 Phonebook: 11
 Editing: 11
 Erasing: 11
 Making calls: 12
 Storing: 11
 PIN
 Base unit: 20
 Handset: 19
 Power on/off (Handset): 8
- R** Range alarm: 17
 Recall: 10
 Redial list: 9
 Redialling: 9
 Registration: 23
 Ringer type: 16
- T** Temporary ringer off: 10
 Time alarm: 16
 Time and date: 8
 Time break recall: 20
- V** Volume
 Receiver: 9
 Ringer (Base unit): 20
 Ringer (Handset): 16
- W** Wall mounting: 29

Dear Purchaser,

You have acquired a product made in compliance with the Digital Enhanced Cordless Telecommunications (DECT) standard. DECT technology is characterized by high-security protection against interceptions as well as high-quality digital transmission. This telephone was designed for a wide range of applications.

For your future reference

Attach or keep original receipt to assist with any repair under warranty.

Serial No. (found on the bottom of the unit)
Date of purchase
Name and address of dealer

Note:

- This equipment is designed for use on the UK and Republic of Ireland analogue telephone network.
- In the event of problems, you should contact your equipment supplier in the first instance.

Declaration of conformity

Hereby, Panasonic Communications Co., Ltd., declares that this Dect Cordless Telephone is in compliance with the essential requirements and other relevant provisions of Directive 1999/5/EC.

A copy of the manufacturer's declaration of conformity to the essential requirements of the R&TTE Directive is available at the following web address:
<http://doc.panasonic-tc.de>

Customer Care Helpline Tel. No.: U.K. 08700 100 076 / R.O.I. 01289 8333
--

CE0436

1999/5/EC

Sales Department:**Panasonic Business Systems U.K.**

Panasonic House, Willoughby Road, Bracknell, Berkshire, RG12 8FP

Manufacturer:**Panasonic Communications Zhuhai Co., Ltd.**

3 Ping Xi 8 Lu, Nanping Keji Gongye Yuan, Zhuhai, Guangdong, China 519060

© 2004 Panasonic Communications Co., Ltd. All Rights Reserved.

PQQX1400ZA DC1203MK0